

**SPH BLIND
SPH CONTACT**

Ø42
LINER XXA

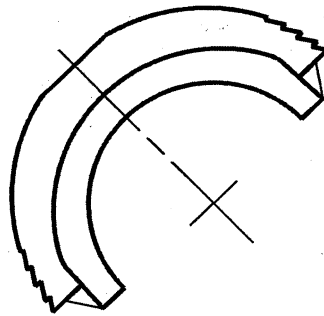

Ø44
LINER XXA

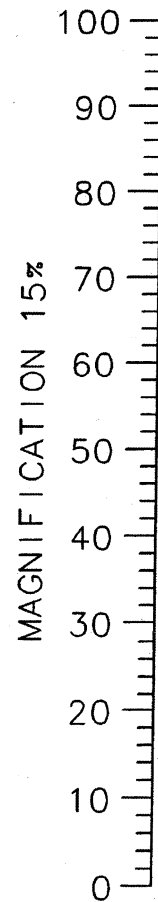
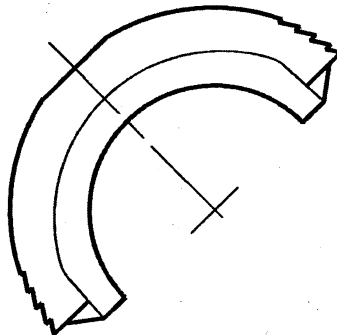

SPH BLIND SPH CONTACT

Ø46
LINER A

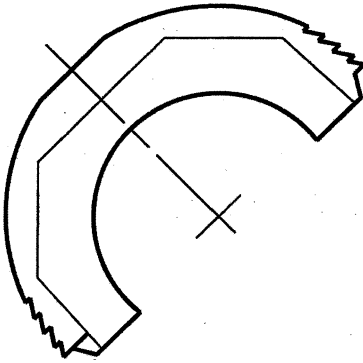

Ø48
LINER A

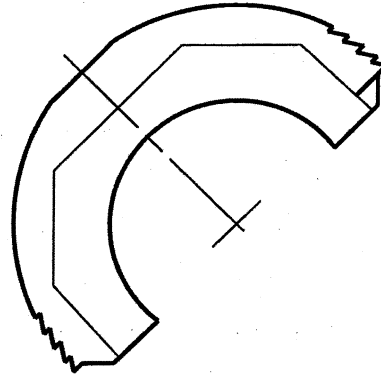

Ø50
LINER B

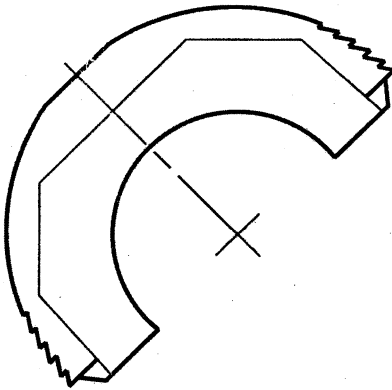

Ø52
LINER B

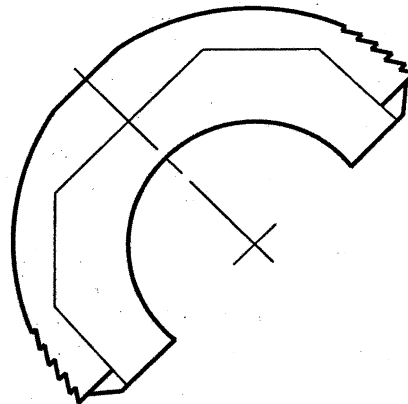

Ø54
LINER C

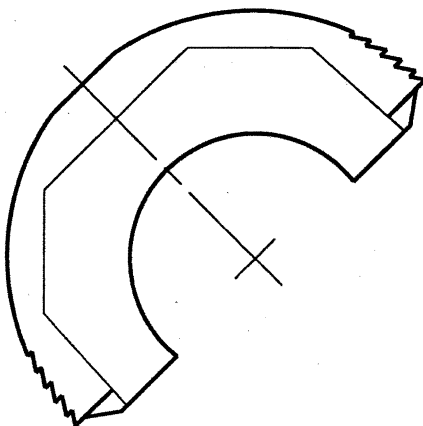

Ø56
LINER C

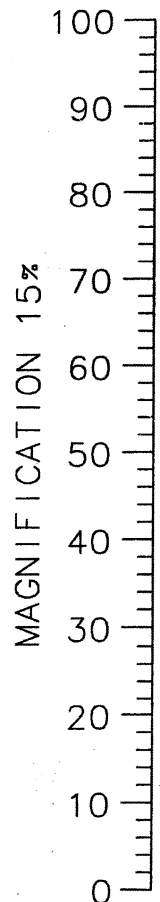
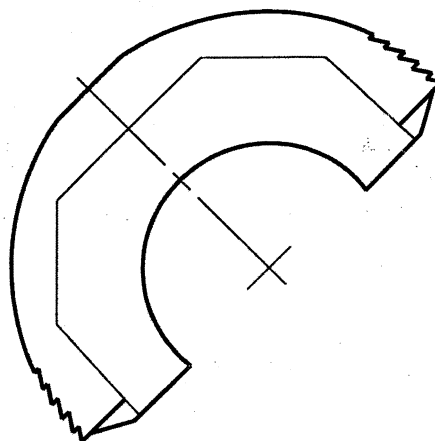

SPH BLIND SPH CONTACT

Ø58
LINER D

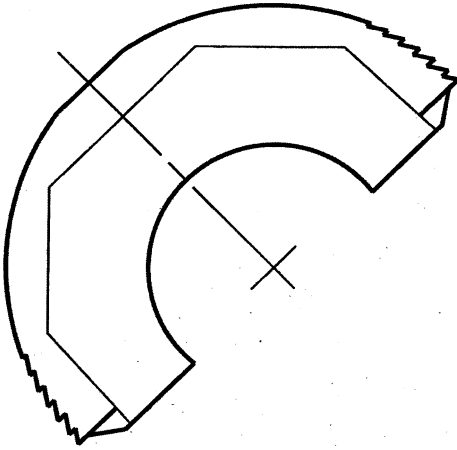

Ø60
LINER D

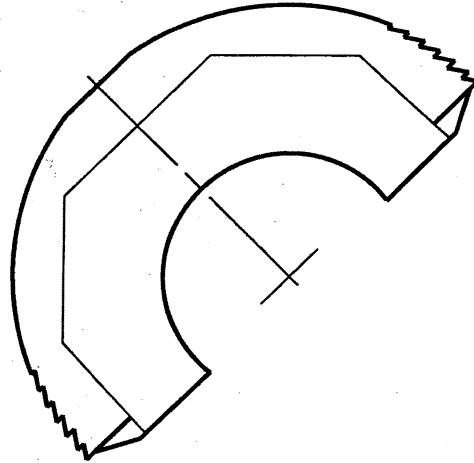

Ø62
LINER D

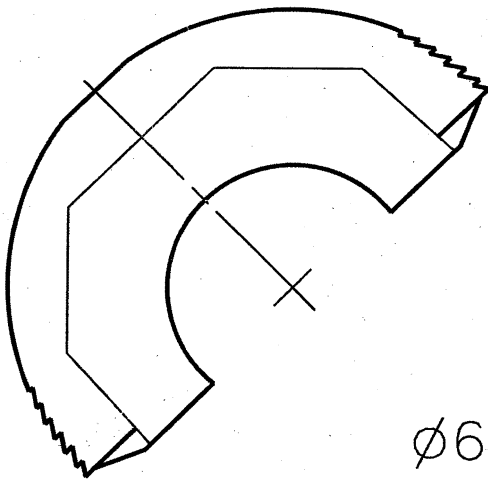

Ø64
LINER E

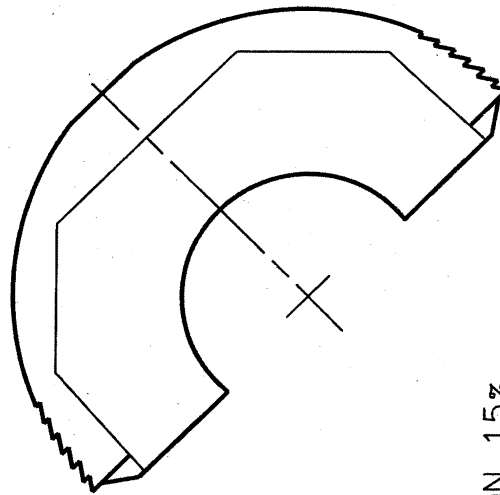

Ø66
LINER E

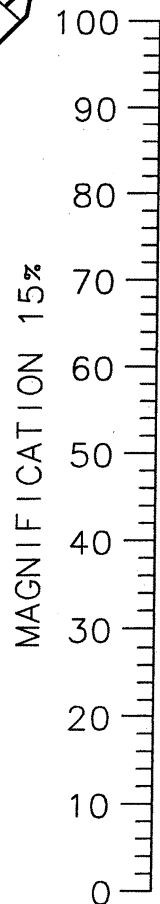
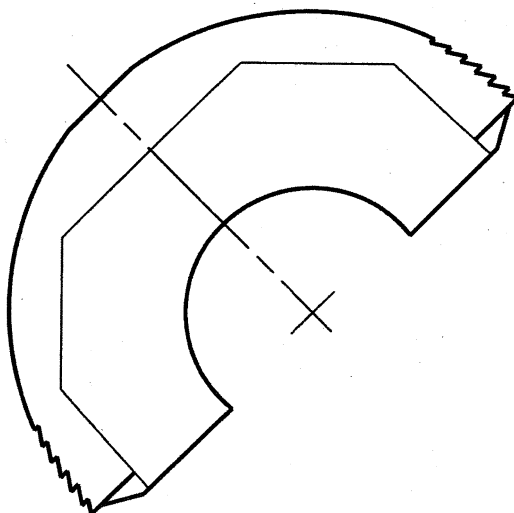

**SPH BLIND
SPH CONTACT**

$\phi 68$
LINER E

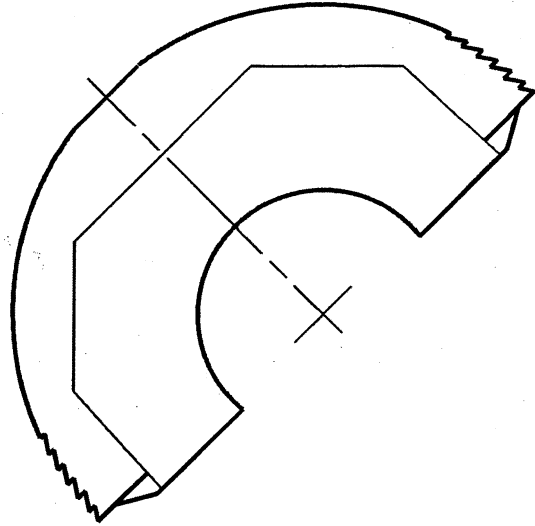

$\phi 70$
LINER E

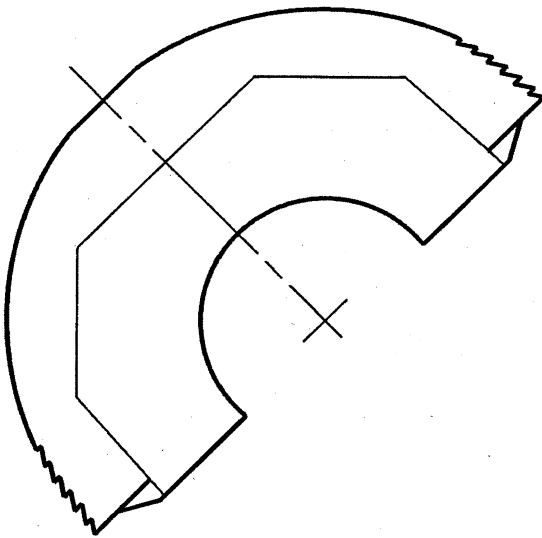

$\phi 72$
LINER E

